

# H T MOULD (CHINA) LTD.

---

PROFILE

# About Us

- H T Mould (China) Limited was founded in 2001, specializing in manufacturing plastic molds and plastic injection molded parts. H T Mould was focus on overseas market. We have two factories one located in Shenzhen City and specialize in producing molds for a wide range of industries: automotive, home appliances, medical equipment, electronics, sporting goods, alloy toy vehicles and electronically controlled toys. Second Factory located in Dongguan City specialize in thin walled product mould making. As food package product have increased rapidly in the past decade. With continuous endeavor and innovation, we developed from a small company into a mold manufacturer of considerable size, running a manufacturing factory in mainland China with over 100 employees. We have successfully developed many projects, including all kinds of the plastic and metal components, such as auto parts, medical devices parts, telecommunication facility parts, office machine parts, consumptive electronics parts and home appliance parts etc. We working hard for the highest quality, best delivery, excellent service and competitive price, and have good reputation from our customers throughout the United States, Europe and Australia. Please don't hesitate to contact us for any assistance, we are looking forward to serve you at any time.

# Development Process

Control & Monitor Process

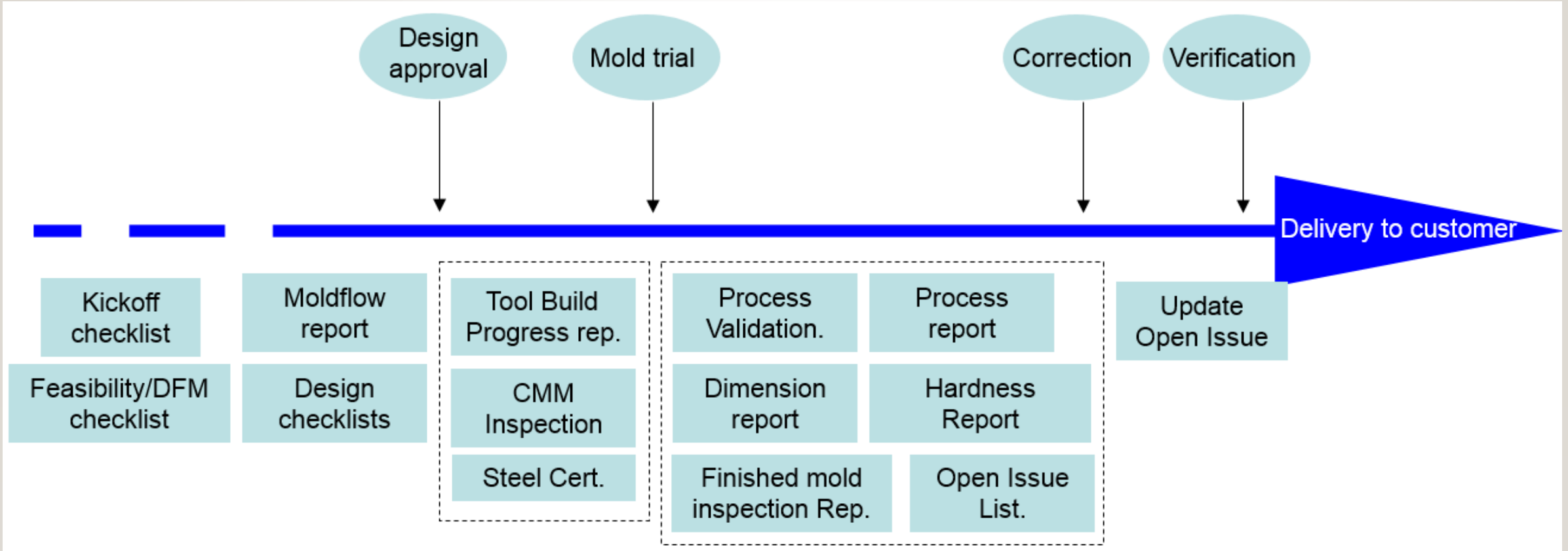





**Dural head EDM**



**2.6M CNC**



**Slow wire cut**

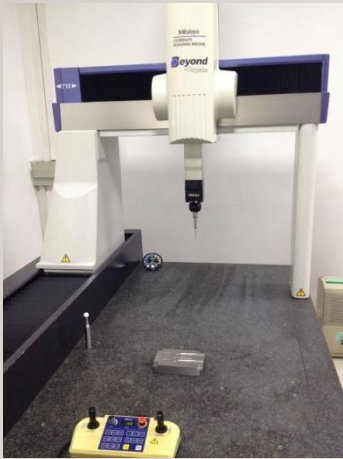

**CMM**



**Measurement  
department**



**Fitting Machine**

Shenzhen plant overview







**Design department**



**Workshop**



**Injection department**



**Grinding Department**



**Polish Department**



**EDM**







CNC Machine



CMM



Workshop



High speed injection machine

Dongguan Thin-walled product plant overview





Thin-walled products are mainly used for food packaging, bubble tea cups, beverage cups, etc.





Thin-walled products are mainly used for food packaging, bubble tea cups, beverage cups, etc.

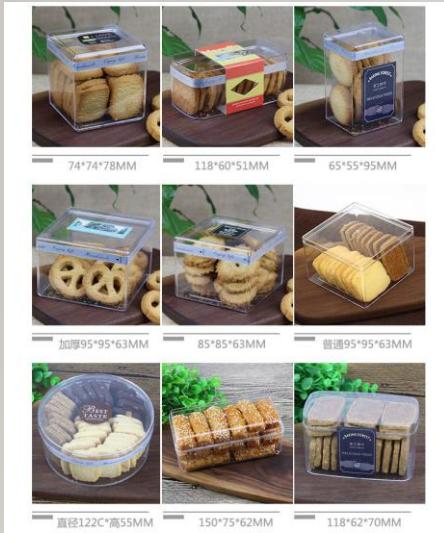



# Thin-walled product - Mould photos

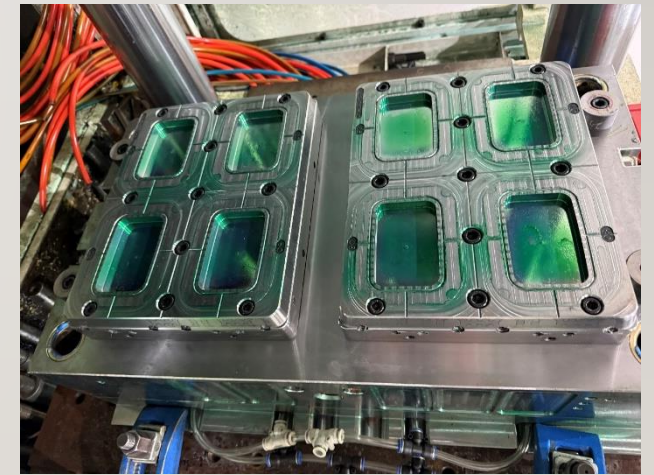
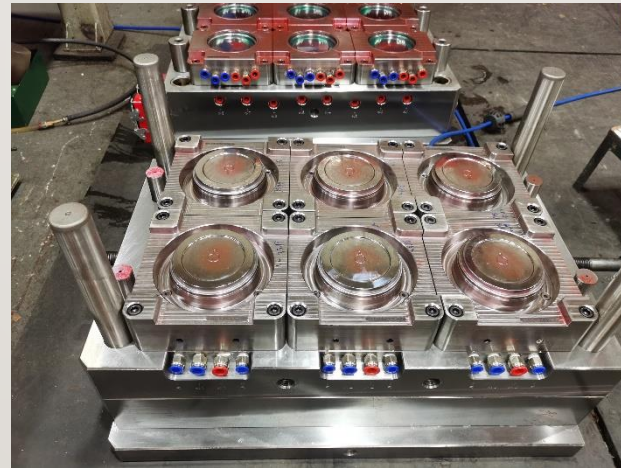
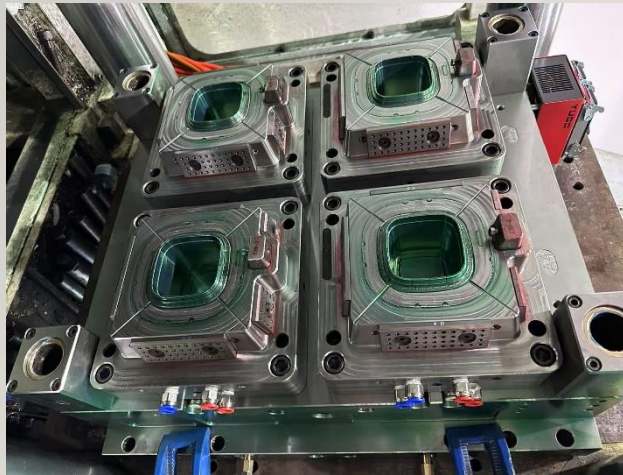
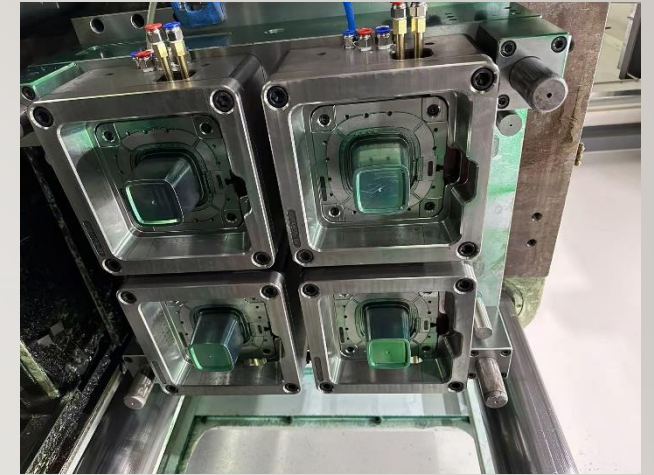
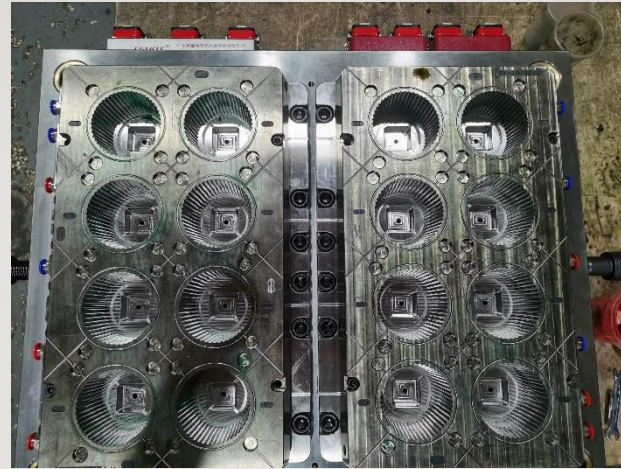
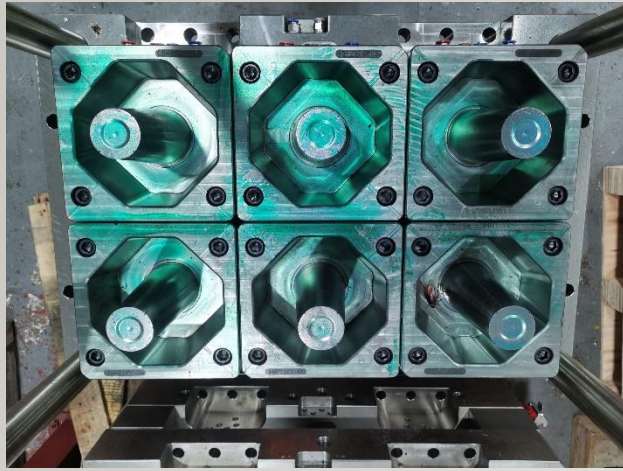



# Medical Product

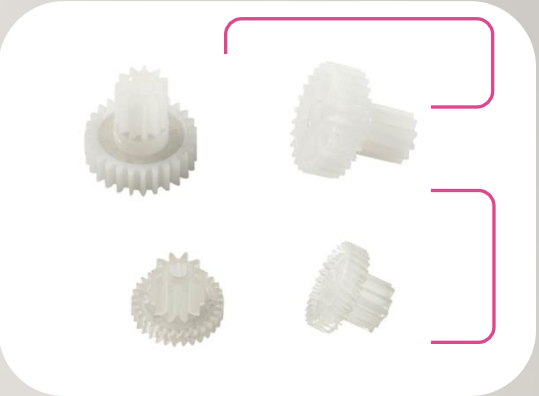



# Medical product - Mould samples

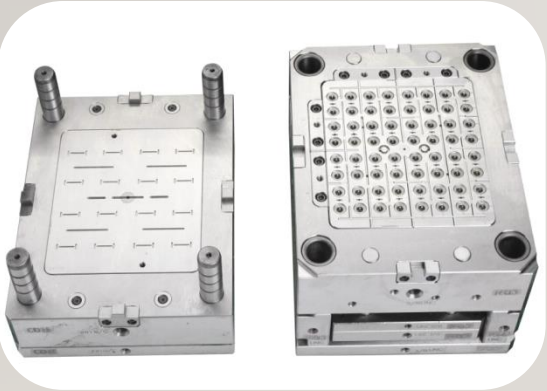
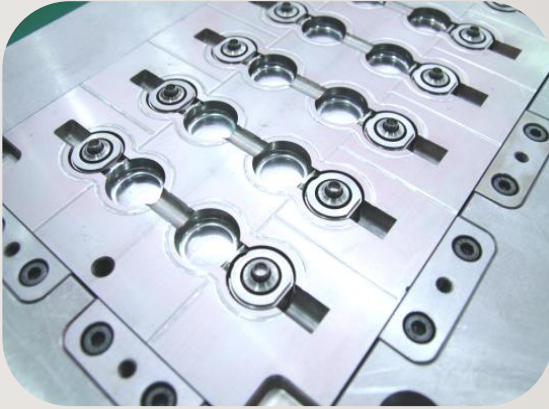

64-cavity



96-cavity

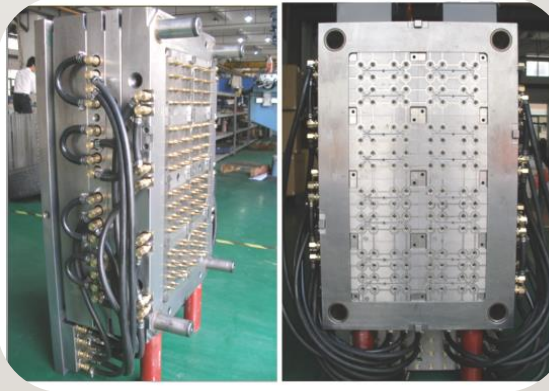

128-cavity

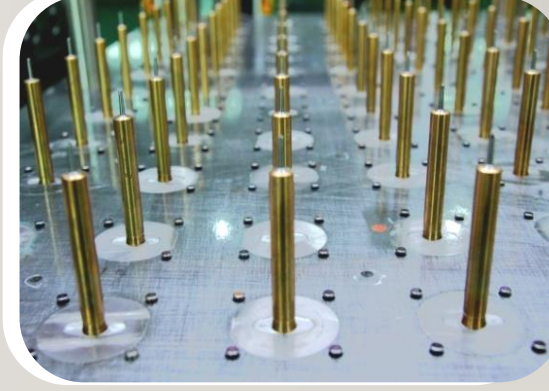

192-cavity



# Automotive product





# Automotive - inner decoration part

---



# Automotive - inner decoration part

---

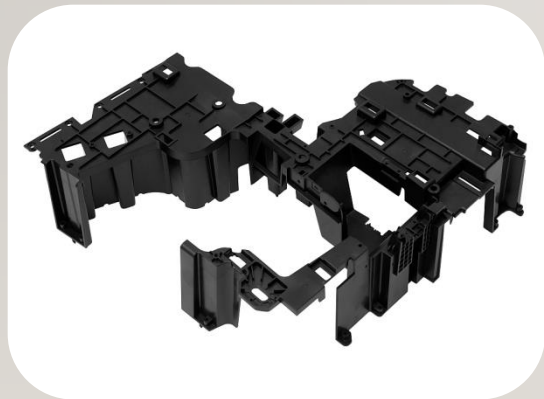



# Automotive - Mould photos

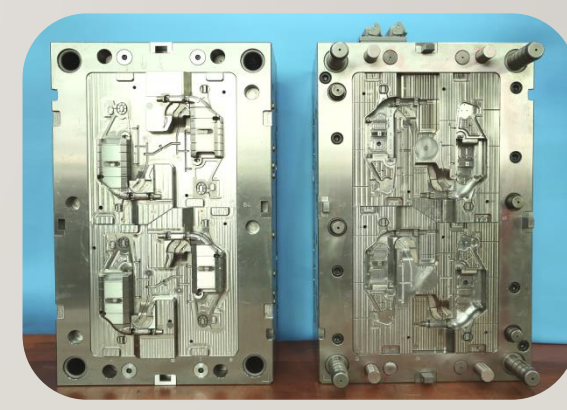
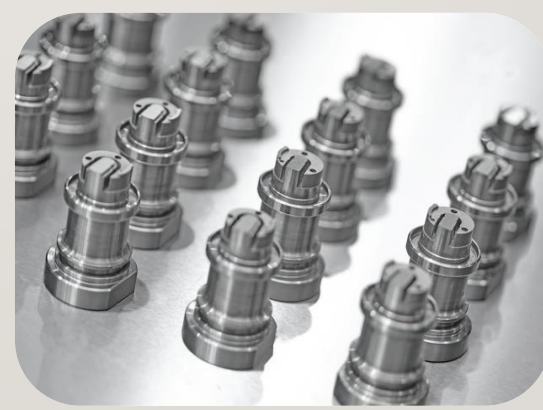
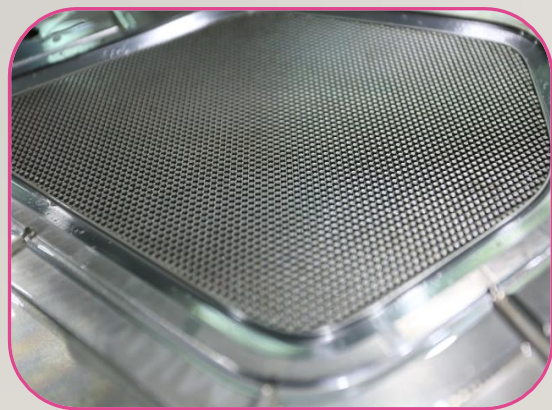
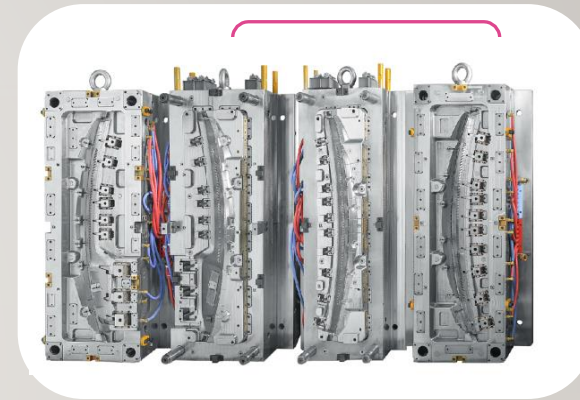
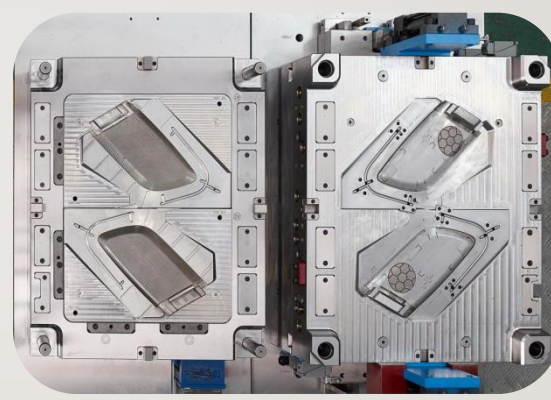
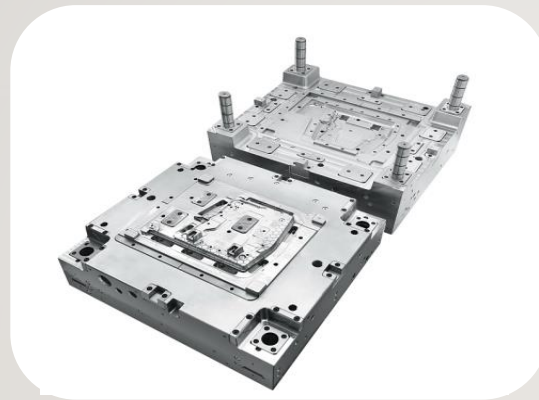
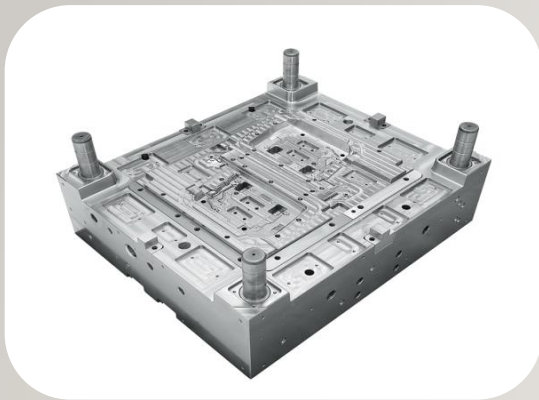

# Automotive Products - Automotive Lighting

---





# Automotive Products - Automotive Lighting Tooling

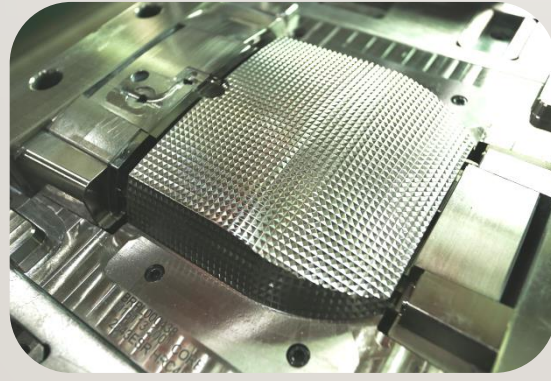
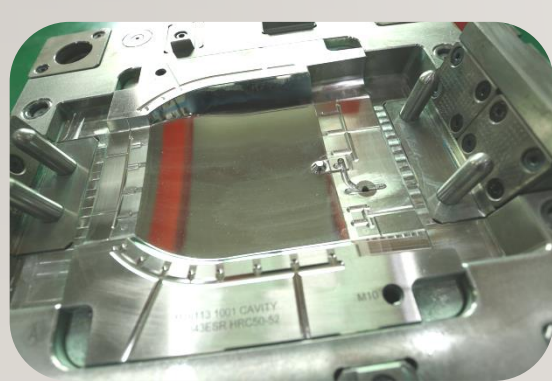
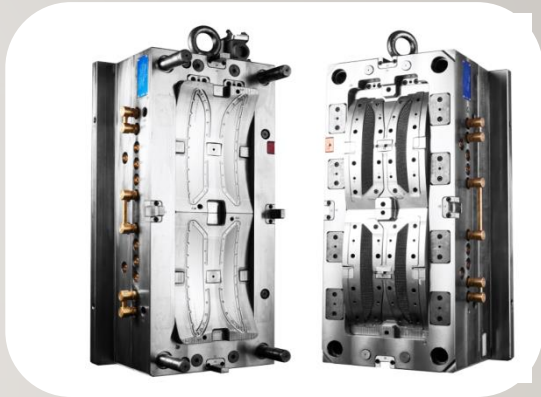
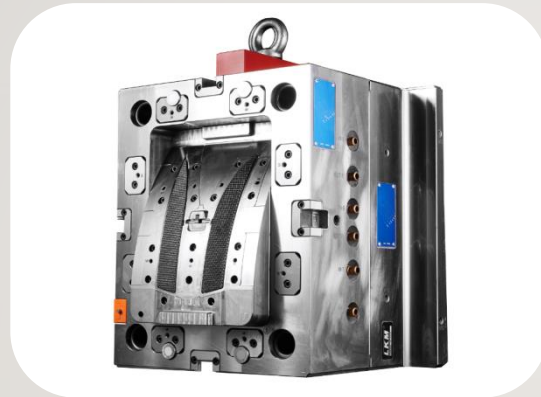
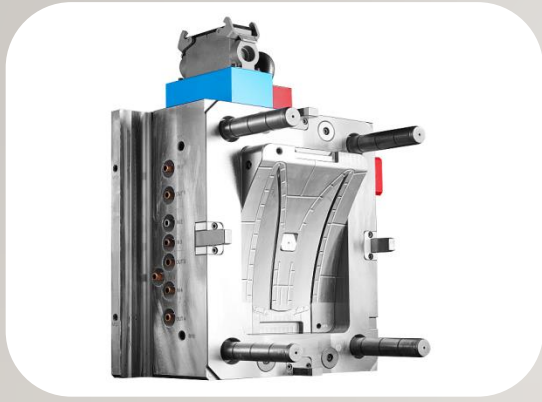

# Electrical parts

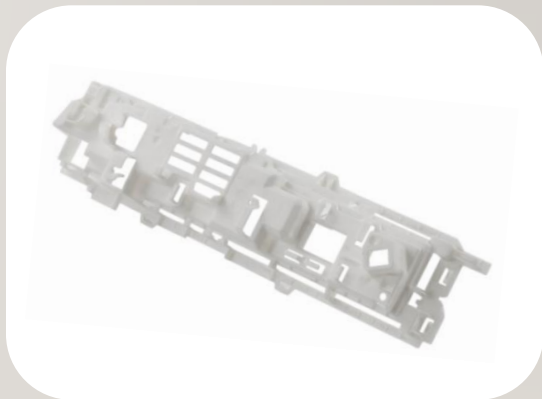
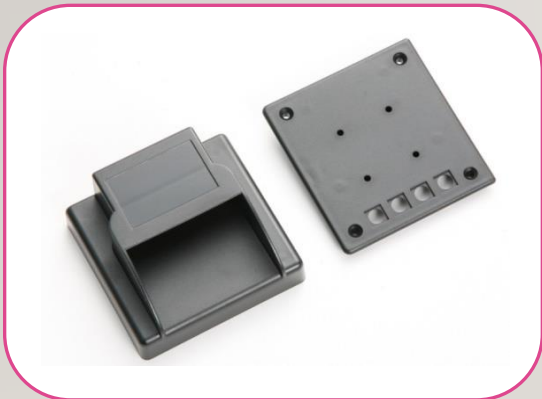
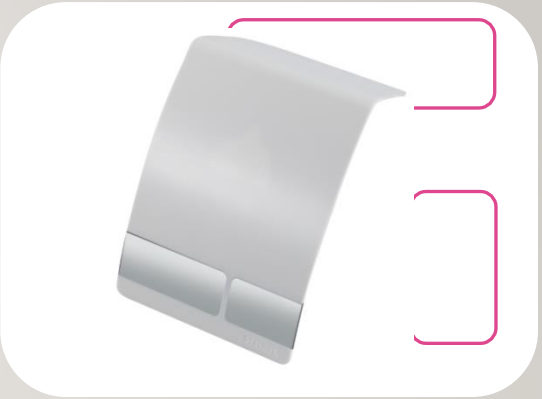
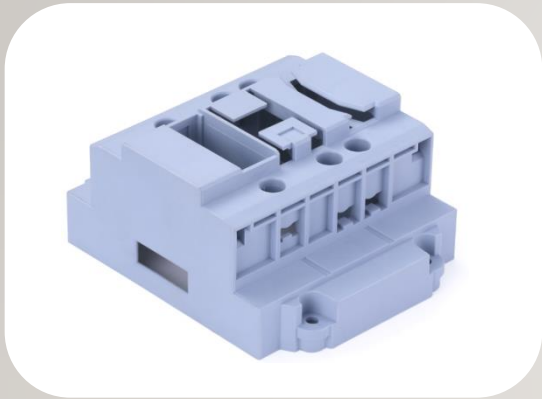



# Household Appliances

---



# Double color molding parts ( two color molding and overmolding )

---





# Precision part



# Precision part mould

